



HOSHIZAKI

UNDERCOUNTER REFRIGERATOR

RT-128MA-S RT-126MA-S

A-FIT cabinets are designed to show outstanding performance and durability backed by Hoshizaki's many years of experience and high-quality standard. The cabinets combine ergonomic design with high functionality and strong cooling capacity to meet customer high expectations.



KEY FEATURES

- > Enhanced cooling capacity with larger evaporator and stronger cooling fan
- > Cleaning-free condenser
- > Ergonomic full-height door
- > HACCP complied design
- > Forced evaporation system
- > Smart auto-defrost system
- > Field reversible door
- > LED interior lighting
- > Removable door gaskets

CERTIFICATION



DIMENSIONS & SPECIFICATION

RT-128MA-S

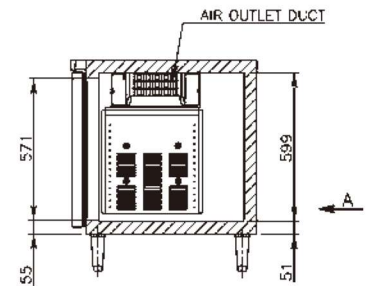
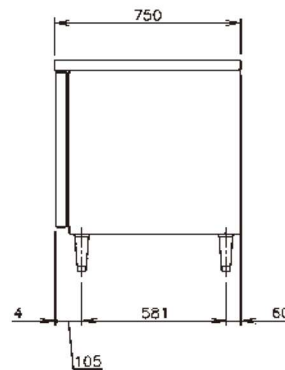
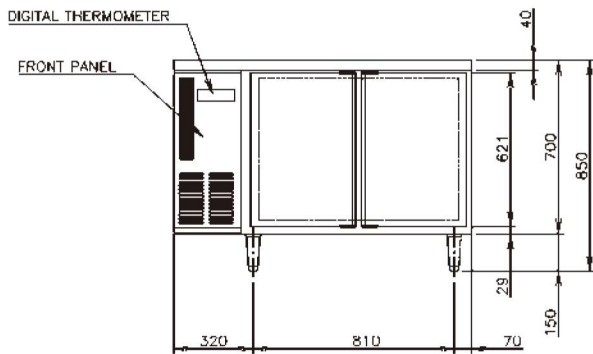
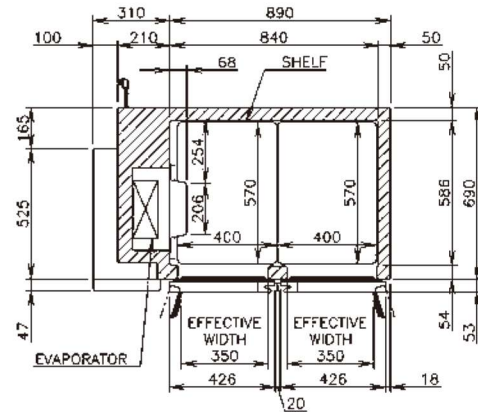
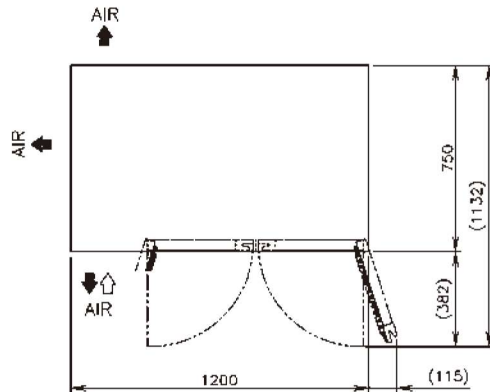
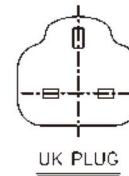
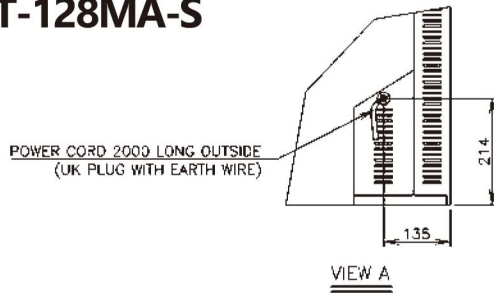

MODEL	RT-128MA-S	RT-126MA-S
TEMP. CONTROL	-6 to 12°C	-6 to 12°C
EFFECTIVE CAPACITY	307 L	231 L
WEIGHT	78 kg (Gross: Approx. 83kg)	71 kg (Gross: Approx. 76kg)
OUTSIDE DIMENSIONS W x D x H (mm)	1200 x 750 x 850(-880)	1200 x 600 x 850(-880)
PACKAGE W x D x H (mm)	1265 x 830 x 790	1265 x 680 x 790
POWER SUPPLY	1 Phase 230V 50Hz Capacity: 0.5kVA (2.5A)	1 Phase 230V 50Hz Capacity: 0.5kVA (2.5A)
ELECTRIC CONSUMPTION	240W Heater: 187W Refrigeration 245W Defrost: 165W	240W Heater: 192W Refrigeration 245W Defrost: 165W
AMPERAGE	Rated 2.0A	Rated 2.0A
SHELF	4pcs.	4pcs.
OPERATING CONDITION	Ambient Temperature: 5-38°C Voltage Range: Rated Voltage ±6%	Ambient Temperature: 5-38°C Voltage Range: Rated Voltage ±6%



HOSHIZAKI

20 Ang Mo Kio Industrial Park 2A, #01-18/19,
AMK Techlink Singapore 567761
Tel : 6253 6001 Fax : 6250 0071
universalsteel.com.sg