

ITCBA, CE 220-240V 29" Trunk W/Tray

Height: 35.0" Width: 11.6" Depth: 22.1"
(88.9cm) (29.5cm) (56.1cm)



- Sleek modernized design language, with rounded angles on the corners and trunk
- Digital readout displays in English, Spanish, or French ---for easier programming and control--- and can show either 'Standard' or Metric measurements. Digital readout also shows machine status, and targeted advertising messages can be programmed for display.
- BUNN Infusion Series technology allows for multiple recipes from one footprint --- with three brew buttons and two batch sizes
- Energy-saver mode reduces tank temperature during idle periods
- Exclusive Peak Extraction™ Sprayhead is multi-directional with a 17-hole design to ensure ultimate uniformity of extraction
- Electronic funnel lock prevents removal of each brew funnel until drip- through is complete
- USB programming capable
- Pre-infusion and pulse brew for maximum flavor extraction. Cold brew lockout & digital temperature control further ensure top-notch brewing.
- Brews into all BUNN iced tea dispensers (except TDS-5), 1.9 to 3.8 liter airpots, thermal carafes --- and can accommodate BUNN ThermoFresh® Servers [servers not included]
- Includes integrated flip tray that converts to three positions: thermal carafe, airpot and tea dispenser

 Server(s) sold separately

Agency:



Specifications

Product #: 52200.0500

Funnel: Black Plastic

Water Access: Plumbed

Interface: Wireless

Finish: Stainless

Additional Features

BrewWISE

Electrical & Capacity

Volts*	Amps	Watts	Cord Attached	Plug Type	8oz cups/hr 236ml cups/hr	Input H ₂ O Temp.	Phase	# Wires plus Ground	Hertz
220-240	13.2-14.1	2900-3400	Yes	EURO 16A	336	60°F (15.5°C)	1	2	50-60

*When a BUNN is machine rated 120/208-240V, 120/208V or 120/240V, the higher voltage is the supply voltage needed to power the machine. The 120V is there to supply power to some components rated 120V in the machine, but it is not the supply voltage and would not power the machine if the machine is marked with the before mentioned ratings.

Plumbing Requirements

PSI	kPa	Fitting Supplied	Water Flow Required (GPM)
20-90	138-621	1/4" Male Flare Fitting	1.25

CAD Drawings

2D	Revit	KLC
●		

 **WARNING:**



BUNN® reserves the right to change specifications and product design without notice. Such revisions do not entitle the buyer to corresponding changes, improvements, additions or replacements for previously purchased equipment. For most current specifications and other info visit bunn.com.

Last Updated:
09/21/2023

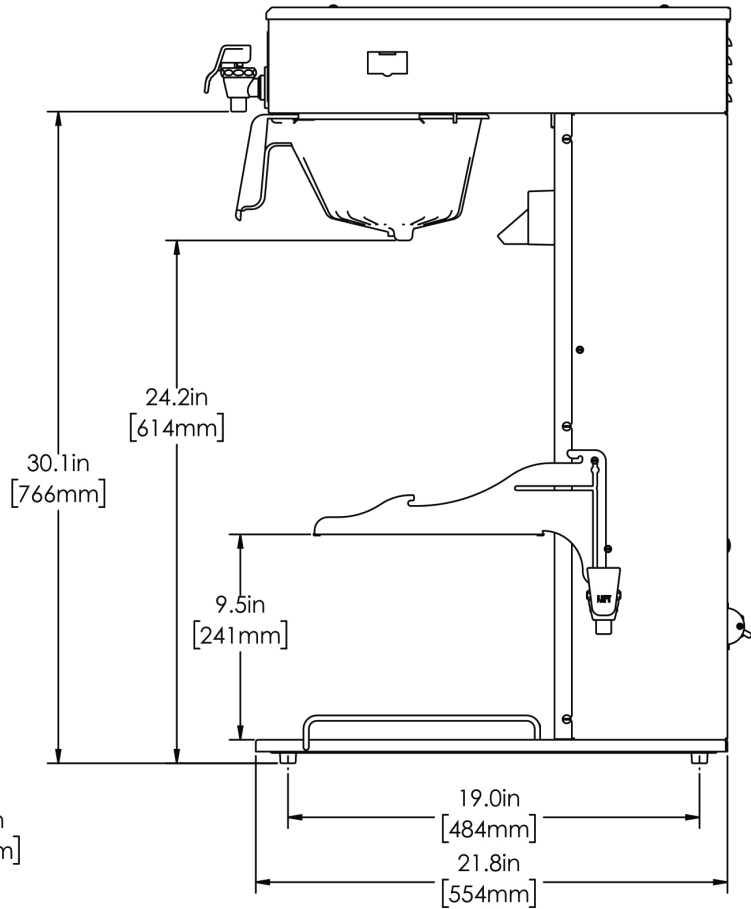
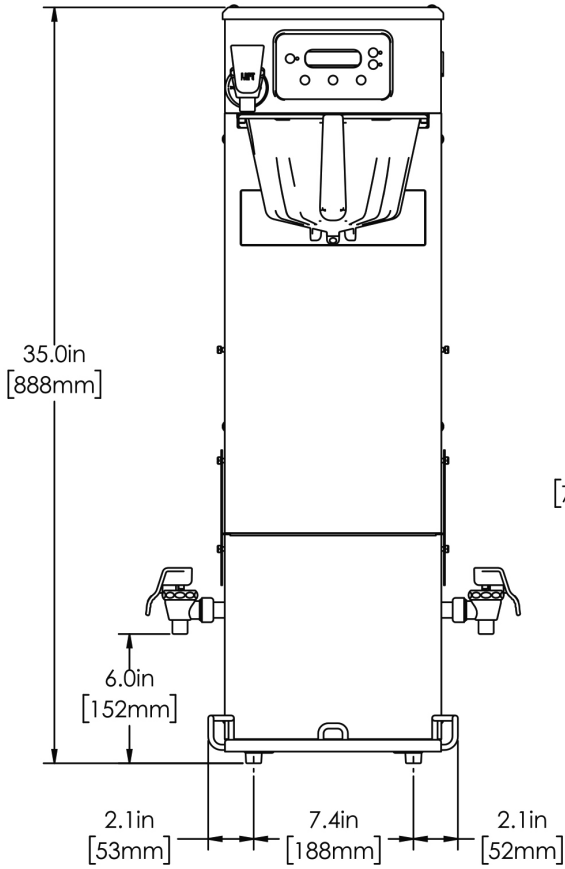
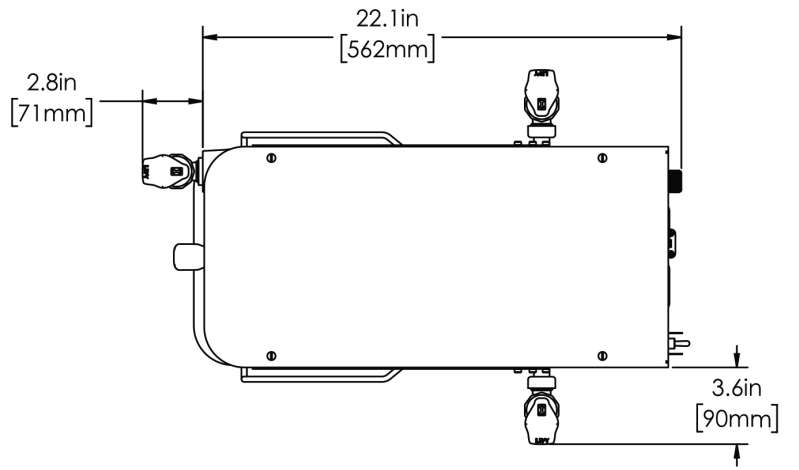

	Unit			Shipping				
	Height	Width	Depth	Height	Width	Depth	Weight	Volume
English	35.0 in.	11.6 in.	22.1 in.	39.0 in.	15.9 in.	27.5 in.	47.600 lbs	9.853 ft ³
Metric	88.9 cm	29.5 cm	56.1 cm	99.1 cm	40.3 cm	69.9 cm	21.591 kgs	0.279 m ³



BUNN® reserves the right to change specifications and product design without notice. Such revisions do not entitle the buyer to corresponding changes, improvements, additions or replacements for previously purchased equipment. For most current specifications and other info visit bunn.com.

Last Updated:
09/21/2023

Related Products & Accessories:ITCBA, CE 220-240V 29" Trunk W/Tray(52200.0500)



FILTERS, GOURMET 500
500/1 50/CL

Product #: 20138.1000



WATER FILTER,
EQHP-10

Product #: 39000.0004



WATER FILTER, EQHP-
TEA

Product #: 39000.0007



FUNNEL ASSY, SMART
COFFEE BLK-CLEARED

Product #: 53463.0021

FUNNEL ASSY, TEA
NATURAL QUICK BREW

Product #: 53463.0023

FUNNEL ASSY, TEA
NATURAL QUICK BREW

Product #: 53463.0036

FUNNEL ASSY, SMART
COFFEE BLK-CLEARED

Product #: 53463.0038

FUNNEL ASSY, TEA
NATURAL QUICK BREW

Product #: 53463.0039



STAND ASSY KIT, TF
SERVER

Product #: 54473.1000



SYSTEM, WQ-55(2)5

Product #: 56000.0004



SYSTEM, WQ-SFTN4000
(1.5)10 TEA

Product #: 56000.0021



SYSTEM, WQ-10(1.5)5

Product #: 56000.0027



SYSTEM, WQ-
SFTN3500(1)10 TEA

Product #: 56000.0030



CARTRIDGE, WQ-55(2)5

Product #: 56000.0104



CARTRIDGE, WQ-10
(1.5)5

Product #: 56000.0122



CARTRIDGE, WQ-
SFTN3500(1)10 TEA

Product #: 56000.0129



CARTRIDGE, WQ-
SFTN4000(1.5)10 TEA

Product #: 56000.0133



BUNN® reserves the right to change specifications and product design without notice. Such revisions do not entitle the buyer to corresponding changes, improvements, additions or replacements for previously purchased equipment. For most current specifications and other info visit bunn.com.

Last Updated:
09/21/2023

Serving & Holding Options: ITCBA, CE 220-240V 29" Trunk W/Tray(52200.0500)



TD4, SIGHT GAUGE
SWT/UNSWT HDL

Product #:03250.0003



TD4T, SIGHT GAUGE
NUDGER HDL

Product #:03250.0004



TD4T, BREW THRU LID
NUDGER HDL

Product #:03250.0005



TD4, BREW THRU LID
SWT/UNSWT HDL

Product #:03250.0006



TD4T, BREW THRU LID
NO DECAL NUDGER
HDL

Product #:03250.0018



AIRPOT, 2.5L GL PB
SINGLE PK

Product #:13041.0001



AIRPOT, 2.5L SST LA
SINGLE PK

Product #:32125.0000



AIRPOT, 3.0L SST LA
SINGLE PK

Product #:32130.0000



TDS-3, 3 GAL

Product #:33000.0000



TDS-3.5, 3.5 GAL

Product #:33000.0023



TDO-4, RESERVOIR

Product #:34100.0000



TDO-5, RESERVOIR

Product #:34100.0001



TDO-4, RESERVOIR
BREW THRU

Product #:34100.0002



TDO-5, RESERVOIR,
BREW THRU

Product #:34100.0003



THERMAL CARAFE, BLK
1.83 L 1PK

Product #:36029.0001



THERMAL CARAFE, ORN
1.9L 1PK

Product #:36252.0001



TDO-N-3.5, RSVR

Product #:39600.0001



TDO-N-3.5, RSVR W/
LIFT HANDLE

Product #:39600.0031



TDO-N-3.5, RSVR W/
PINCH TUBE

Product #:39600.0047



CARAFE, SST 1.9L SHRT
BLK 1

Product #:40163.0000



BUNN® reserves the right to change specifications and product design without notice. Such revisions do not entitle the buyer to corresponding changes, improvements, additions or replacements for previously purchased equipment. For most current specifications and other info visit bunn.com.

Last Updated:
09/21/2023

Serving & Holding Options: ITCBA, CE 220-240V 29" Trunk W/Tray(52200.0500)



TF SERVER, 1G DSG
GEN3 NOBASE

Product #:42700.0250



TF SERVER, 1G MECH
GEN3 NOBASE

Product #:44000.0250



BUNN® reserves the right to change specifications and product design without notice. Such revisions do not entitle the buyer to corresponding changes, improvements, additions or replacements for previously purchased equipment. For most current specifications and other info visit bunn.com.

Last Updated:
09/21/2023