



HOSHIZAKI

> B-301SA



> B-501SA



> B-801SA



- > **B-301SA**
- > **B-501SA**
- > **B-801SA**

Storage bins are essential to ensure continuous supply of ice and these bins are made to match Hoshizaki Ice Machines. Made from stainless steel, the bins are easy to clean.

FEATURES

- > sturdy construction for side by side or stacked installations
- > non-corrosive bin liner for sanitary storage of ice
- > foamed in-place insulation in all bin walls for low melting rate
- > round edges for easy cleaning

STORAGE CAPACITY

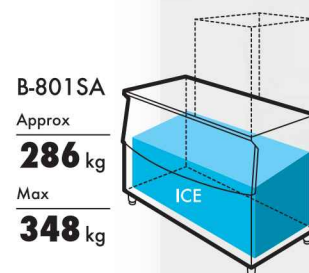
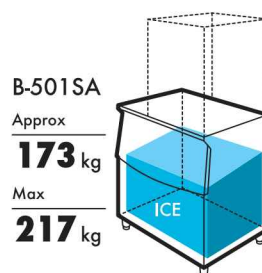
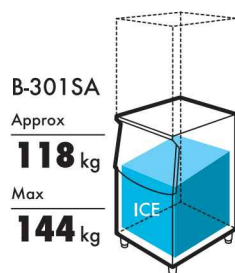

ICE STORAGE BIN SERIES

DIMENSIONS & SPECIFICATION

● B-301SA

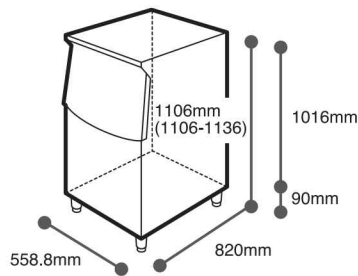

BACK SIDE

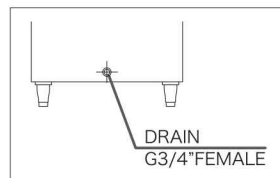

● B-501SA

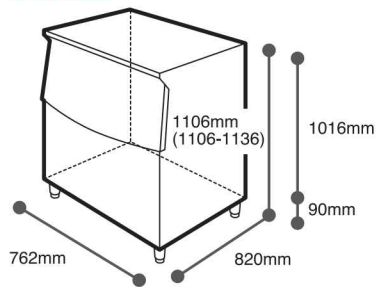

BACK SIDE

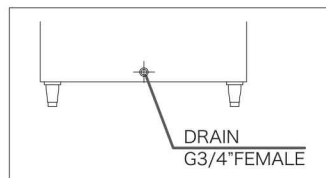

● B-801SA

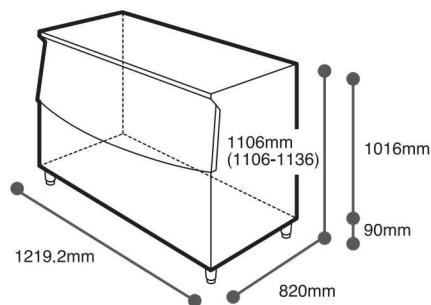

BACK SIDE

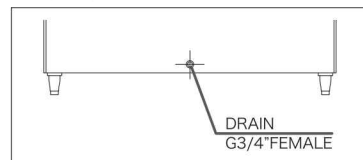

SPECIFICATION

MODEL NAME	B-301SA	B-501SA	B-801SA
STORAGE CAPACITY	Approx : 118kg / Max : 144kg	Approx : 173kg / Max : 217kg	Approx : 286kg / Max : 348kg
OUTSIDE DIMENSIONS(W x D x H)	558.8 x 820 x 1106(1106-1136)(mm)	762 x 820 x 1106(1106-1136)(mm)	1219.2 x 820 x 1106(1106-1136)(mm)
DOOR STYLE	Upward Opening	Upward Opening	Upward Opening
INSULATION	Polyurethane Foam	Polyurethane Foam	Polyurethane Foam
ACCESSORIES	Scoop , Leg (4 pcs)	Scoop , Leg (4 pcs)	Scoop , Leg (4 pcs)
WEIGHT (NET / GROSS)	37kg / 49Kg	47kg / 62kg	64kg / 86kg

COMBINATION

Ice machine	FM-300 FM-480 FM-600 IM-240A IM-220AA	KM-515 KM-650 KMD-201 KMD-270	KM-900	FM-251x2 FM-481x2 FM-600x2 IM-240Ax2	KMD201x2 KMD270x2 IM-220AAx2	KM-1301	IM-240D
B-301SA							
Top Kit	No Top Kit						
B-501SA							
Top Kit	8D	No Top Kit					
B-801SA							
Top Kit	8D+18D	18D	4DM	4DM+4DR	Not Top Kit	1MD	