

DUAL TF DBC® SST

Height: 35.7" Width: 21.8" Depth: 23.8"
(90.7cm) (55.4cm) (60.5cm)



- Brews 16.3 to 18.9gal (61.7 to 71.5L) of perfect coffee per hour
- Coffee extraction controlled with pre-infusion and pulse brew, digital temperature control, and large sprayhead; coffee strength controlled with variable by-pass.
- Create coffee recipe cards with custom recipes, ad cards with messages that display on the brewer LCD, and dedicated funnels for special coffees with the BrewWISE Recipe Writer using your PC (Windows® compatible).
- Easy pulse interface allows automatic programming of pulse routine
- Preventive maintenance kit: 39641.0000
- SplashGard® funnel and optional funnel locks help improve safety
- Stores individual coffee recipes so operator can easily brew many varieties
- ThermoFresh® servers are vacuum insulated to keep coffee hot for hours.
- Energy saver mode reduces tank temperature during idle periods
- Operate any combination of BrewWISE equipment error-free with wireless brewer-grinder interface through Smart Funnel with SplashGard®
- Servers not included unless otherwise noted

Server(s) sold separately

Agency:



Specifications

Product #: 34600.0011

Funnel: Smart Funnel

Water Access: Plumbed

Faucet: Lower

Interface: Wireless

Finish: Stainless

Additional Features

BrewWISE

Electrical & Capacity

Volts*	Amps	Watts	Cord Attached	Plug Type	8oz cups/hr 236ml cups/hr	Input H ₂ O Temp.	Phase	# Wires plus Ground	Hertz
220-240	27.0-29.5	6000-7100	No	-	283	60°F (15.5°C)	1	2	50-60

*When a BUNN is machine rated 120/208-240V, 120/208V or 120/240V, the higher voltage is the supply voltage needed to power the machine. The 120V is there to supply power to some components rated 120V in the machine, but it is not the supply voltage and would not power the machine if the machine is marked with the before mentioned ratings.

Plumbing Requirements

PSI	kPa	Fitting Supplied	Water Flow Required (GPM)
20-90	138-621	3/8" Male Flare Fitting	-

CAD Drawings

2D	Revit	KLC
●		

WARNING:



BUNN® reserves the right to change specifications and product design without notice. Such revisions do not entitle the buyer to corresponding changes, improvements, additions or replacements for previously purchased equipment. For most current specifications and other info visit bunn.com.

Last Updated:
12/07/2023

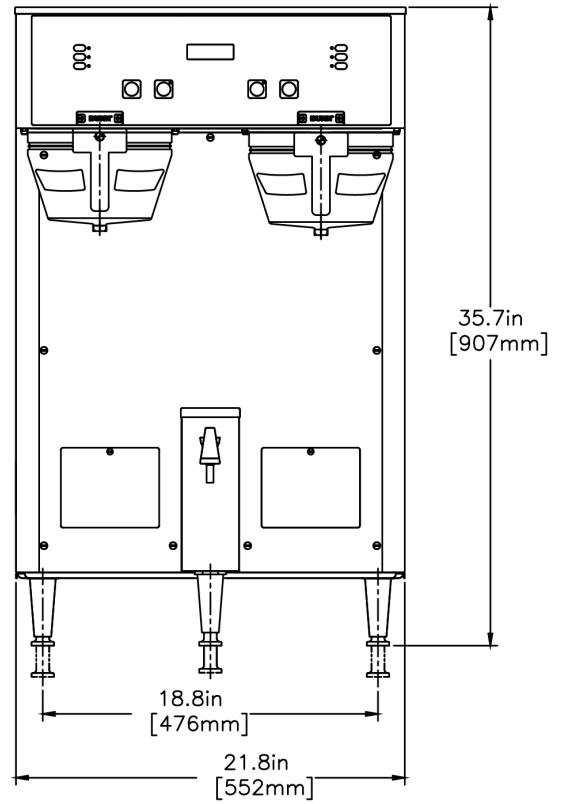
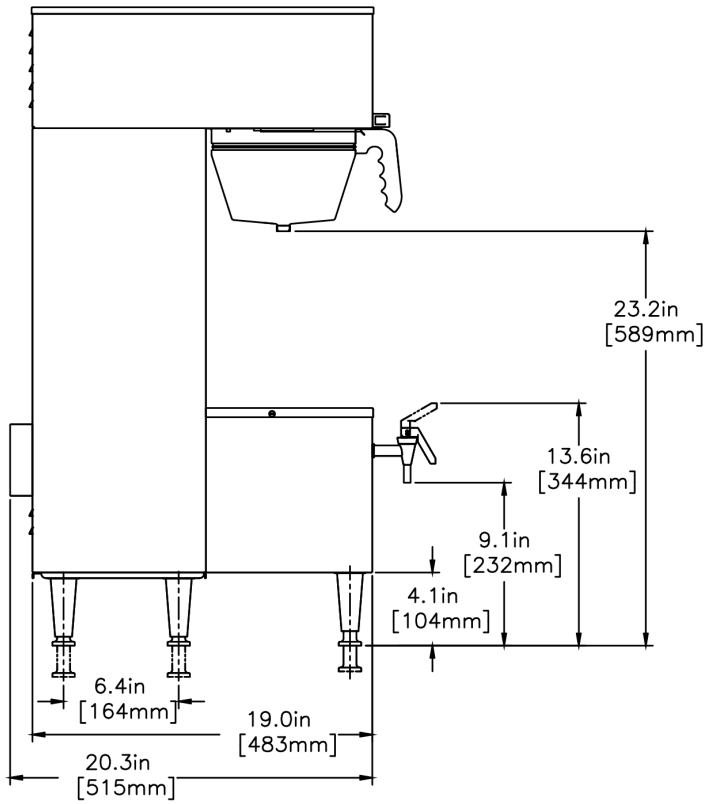
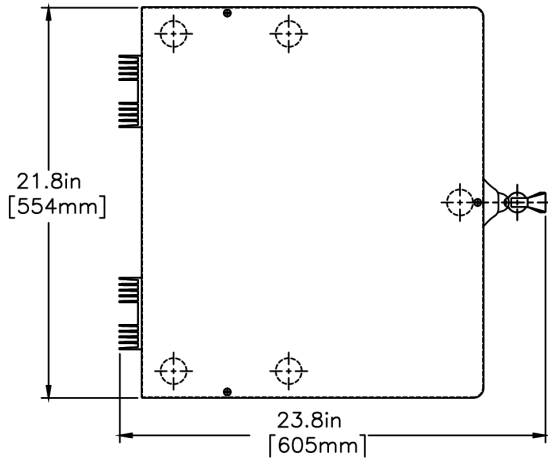

	Unit			Shipping				
	Height	Width	Depth	Height	Width	Depth	Weight	Volume
English	35.7 in.	21.8 in.	23.8 in.	38.8 in.	24.7 in.	25.9 in.	92.200 lbs	14.360 ft ³
Metric	90.7 cm	55.4 cm	60.5 cm	98.4 cm	62.7 cm	65.9 cm	41.822 kgs	0.407 m ³



BUNN® reserves the right to change specifications and product design without notice. Such revisions do not entitle the buyer to corresponding changes, improvements, additions or replacements for previously purchased equipment. For most current specifications and other info visit bunn.com.

Last Updated:
12/07/2023

Related Products & Accessories: DUAL TF DBC® SST(34600.0011)



FILTERS, GOURMET 500
500/1 50/CL

Product #: 20138.1000



FUNNEL ASSY, W/
INSERTS SMTF

Product #: 32643.0000

CARD ASSY, RECIPE
TRANSFER (BRW)

Product #: 34447.0016



MHGA, CE IPX1 EURO
220-240V BLK 50HZ

Product #: 35600.0023



WATER FILTER,
EQHP-25L

Product #: 39000.0002



WATER FILTER,
EQHP-25

Product #: 39000.0005



SYSTEM, WQ-55(3).2L

Product #: 56000.0002



SYSTEM, WQ-55(3).2

Product #: 56000.0005



SYSTEM, WEQ-25(2).2L

Product #: 56000.0025



SYSTEM, WEQ-25(2).2

Product #: 56000.0028



CARTRIDGE, WQ-55
(3).2L

Product #: 56000.0102



CARTRIDGE, WQ-55(3).2

Product #: 56000.0105



CARTRIDGE, WEQ-25
(2).2L

Product #: 56000.0123



CARTRIDGE, WEQ-25
(2).2

Product #: 56000.0124



BUNN® reserves the right to change specifications and product design without notice. Such revisions do not entitle the buyer to corresponding changes, improvements, additions or replacements for previously purchased equipment. For most current specifications and other info visit bunn.com.

Last Updated:
12/07/2023

Serving & Holding Options: DUAL TF DBC® SST(34600.0011)



TF SERVER, DSG2
1G/3.8L

Product #:42700.0000



TF SERVER, DSG2 1.5G
SST

Product #:42750.0000



TF SERVER, DSG2 1.5G
BLK

Product #:42750.0001



TF SERVER, DSG2 1.5G
CD

Product #:42750.0003



TF SERVER, 1G/3.8L
MECH

Product #:44000.0000



TF SERVER, 1.5G/5.7L
MECH

Product #:44050.0000



TF SERVER, 1.5G/5.7L
MECH BLK

Product #:44050.0001



BUNN® reserves the right to change specifications and product design without notice. Such revisions do not entitle the buyer to corresponding changes, improvements, additions or replacements for previously purchased equipment. For most current specifications and other info visit bunn.com.

Last Updated:
12/07/2023