

H5XA Element SST, CE EURO

Height: 28.5" (72.4cm) Width: 7.1" (18.0cm) Depth: 18.9" (48.0cm)



- LED display provides simple temperature adjustment
- Thinsulate® tank insulation provides increased energy efficiency
- Digital thermostat provides constant and accurate temperatures of 60°- 212°F (15.6°-100°C)
- Programmable "Energy Saver Mode" reduces operating cost during idle periods
- The perfect tool for added control over quality coffee and tea
- Contemporary, space-saving design

Agency:



Specifications

Product #: 43600.0013

Temp. Setting: 212°F (100.000°C)

Water Access: Plumbed

Dispense: Pull & Hold

Finish: Stainless

Faucet: Upper

Additional Features

Electrical & Capacity

Volts*	Amps	Watts	Cord Attached	Plug Type	8oz cups/hr 236ml cups/hr	Input H ² O Temp.	Phase	# Wires plus Ground	Hertz
220-240	15.5-16	3400-3800	Yes	EURO 16A	-	60°F (15.5°C)	1	2	50/60

*When a BUNN is machine rated 120/208-240V, 120/208V or 120/240V, the higher voltage is the supply voltage needed to power the machine. The 120V is there to supply power to some components rated 120V in the machine, but it is not the supply voltage and would not power the machine if the machine is marked with the before mentioned ratings.

Plumbing Requirements

PSI	kPa	Fitting Supplied	Water Flow Required (GPM)
20-90	138-621	1/4" Male Flare Fitting	-

CAD Drawings

2D	Revit	KLC
●		

WARNING:



BUNN® reserves the right to change specifications and product design without notice. Such revisions do not entitle the buyer to corresponding changes, improvements, additions or replacements for previously purchased equipment. For most current specifications and other info visit bunn.com.

Last Updated:
12/06/2023

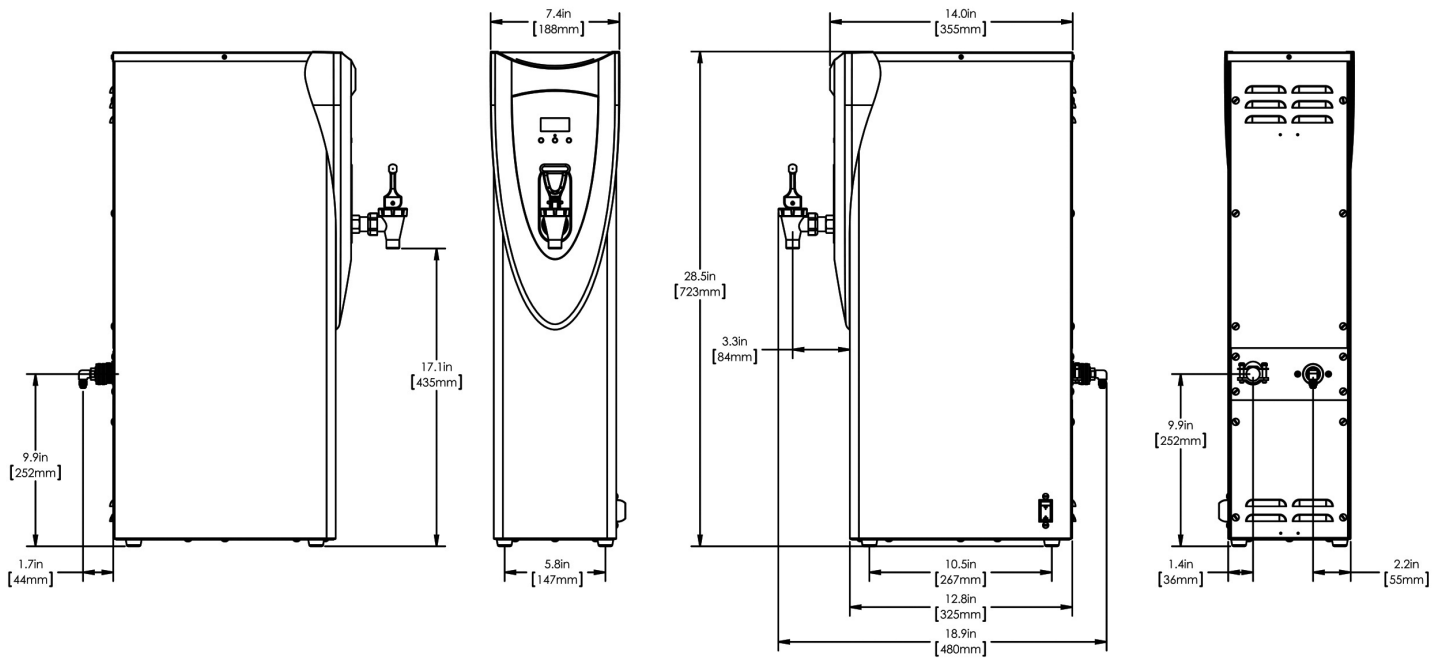
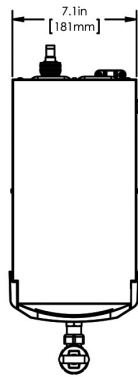

Unit				Shipping				
	Height	Width	Depth	Height	Width	Depth	Weight	Volume
English	28.5 in.	7.1 in.	18.9 in.	32.9 in.	11.0 in.	20.7 in.	33.300 lbs	4.338 ft ³
Metric	72.4 cm	18.0 cm	48.0 cm	83.7 cm	27.9 cm	52.5 cm	15.105 kgs	0.123 m ³



BUNN® reserves the right to change specifications and product design without notice. Such revisions do not entitle the buyer to corresponding changes, improvements, additions or replacements for previously purchased equipment. For most current specifications and other info visit bunn.com.

Last Updated:
12/06/2023

Related Products & Accessories:H5XA Element SST, CE EURO(43600.0013)



DRIP TRAY KIT (2.5"HT-HW2)

Product #: 02497.0000



DRIP TRAY

Product #: 02545.0000

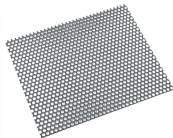

COVER, DRIP TRAY-PERFORATED

Product #: 02546.0000



FOOT, RUBBER

Product #: 02547.0000

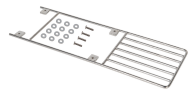

KIT, SHELF

Product #: 12599.0000

WALL BRKT KIT, FRONT MTG-H5

Product #: 13125.0003



WATER FILTER, EQHP-10L

Product #: 39000.0001



WATER FILTER, EQHP-10

Product #: 39000.0004



SYSTEM, WQ-55(2)5L

Product #: 56000.0001



SYSTEM, WQ-55(2)5

Product #: 56000.0004



SYSTEM, WEQ-10(1.5)5L

Product #: 56000.0024



SYSTEM, WEQ-10(1.5)5

Product #: 56000.0027



CARTRIDGE, WQ-55(2)5L

Product #: 56000.0101



CARTRIDGE, WQ-55(2)5

Product #: 56000.0104



CARTRIDGE, WEQ-10(1.5)5L

Product #: 56000.0121



CARTRIDGE, WEQ-10(1.5)5

Product #: 56000.0122

Serving & Holding Options: H5XA Element SST, CE EURO(43600.0013)

Serving and Holding selections are currently unavailable. Please contact your sales representative to find out more information.



BUNN® reserves the right to change specifications and product design without notice. Such revisions do not entitle the buyer to corresponding changes, improvements, additions or replacements for previously purchased equipment. For most current specifications and other info visit bunn.com.

Last Updated:
12/06/2023